

Ideal BarStation® 2

IBS 2C BA



Natural Golden Bamboo

IBS 2C GT

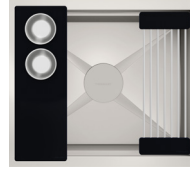

Graphite Wood Composite

IBS 2C WH

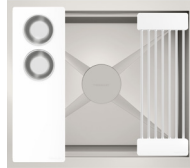

Designer White Resin*

IBS 2C GR

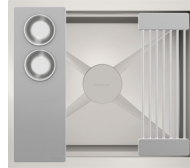

Exclusive Gray Resin*

Specifications

Single bowl
 Users: 1
 Bar Tools included: Two (4 pcs)
 Galley BarTap, recommended: One
 Outside dimensions: 22" x 19 1/2" x 10 5/16"
 Counter top cutout: 21" x 18"
 Basin area: 20 1/2" x 16"
 Minimum cabinet size: 24" or 60cm

Bar Tools included

- (1) Upper Tier Garnish Cutting Board 6" x 18"
- (1) Lower Tier Mini Drying Rack 6" x 17"

Basin construction

16GA 316L stainless steel indoor/outdoor
 Angel finish
 Two tier design
 Star™ groove pattern
 Center drain
 Elevated drain cover included
 Limited Lifetime Warranty
 Made in the USA
 ASME A112.19.3/CSA B45.4 certified

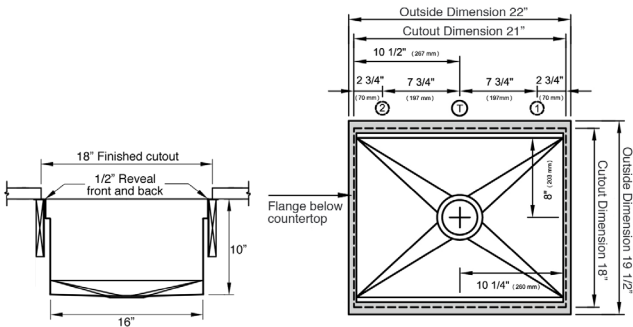

Suggested maximum inside corner radius of counter top cutout 3/8"
 Center Tap hole diameters 2" behind cutout
 T. Galley Tap/BarTap 1 3/8" min hole diameter (1 1/2" min hole diameter for fast water jet cut)
 1. Galley Deck Switch 1 3/8" min hole diameter or Galley Soap Dispenser 1" min to 1 3/8" max hole diameter
 2. Galley Hot and Cold Water Dispenser 1 3/8" min hole diameter (1 1/2" min hole diameter for fast water jet cut) or Galley Deck Switch or Galley Soap Dispenser
 *Galley Hot and Cold Water dispenser requires a minimum 8" clearance to center if installed to the right of the Galley Tap

Upper Deck™ (Optional)

Upper Deck set **UD 2 2P GT/BA/WH/GR** Graphite, Bamboo, White or Gray Resin

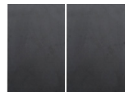

12" 12"

Upper Deck sections Graphite, Bamboo, White or Gray Resin

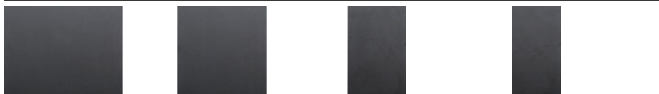

UD24IGT/BA/WH/GR UD18IGT/BA/WH/GR UD12IGT/BA/WH/GR UD09IGT/BA/WH/GR

Recommended Workstation Accessories

Bottom Grate set **BG 2 C 1 SS** Stainless Steel

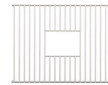

20"

Manual Strainer Basket

MDRNMSS Angel Finish Stainless Steel



Disposal Flange Strainer Basket

GDRNMSS Angel Finish Stainless Steel



Auto Strainer Basket Angel Finish Stainless Steel with Polished or Matte knob



ADRNPSS
ADRNMSS