

Liberty
Part # - MTPS-108

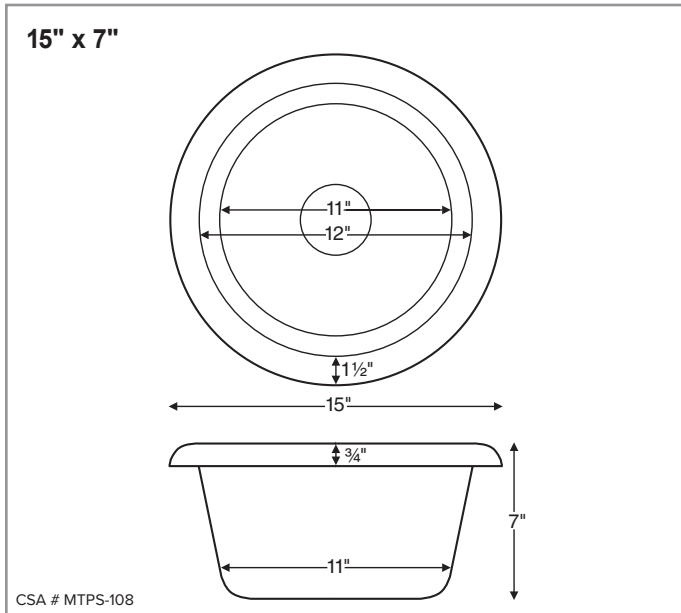

OPTIONS

- White (MTPS108W) **\$340**
- Biscuit (MTPS108B) **\$350**
- Quick Ship / Priority. *Call for availability.* (QUISINKSH) **\$215**
- Shipping Weight: 10 lbs

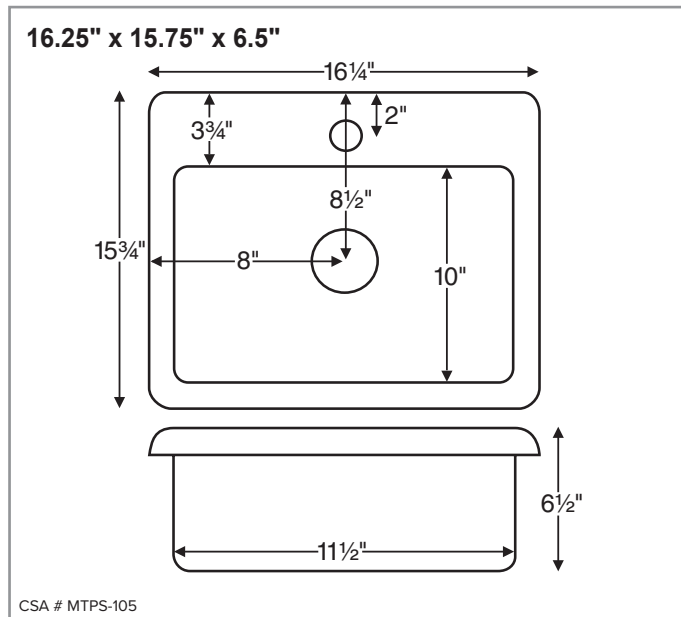

Sequel
Part # - MTBS-105

OPTIONS

- White (MTBS105W) **\$295**
- Biscuit (MTBS105B) **\$305**
- OPTIONS**
- Quick Ship / Priority. *Call for availability.* (QUISINKSH) **\$215**
- Shipping Weight: 7 lbs

CONSTRUCTION AND STANDARD FEATURES

- Due to the particular shape of this sink, MTI recommends having the product on site before attempting any cut-out in counter top material.
- Single-bowl design; accommodates 3.5" kitchen sink drain
- Can be undermounted or caulked directly to the countertop without the use of clips or channels.
- No holes can be drilled for Liberty or Harvest. For Sequel, no holes drilled if undermounting. Installer will drill onsite.
- Durable shell is extremely scratch- and stain-resistant yet renewable because the color goes all the way through the material.
- Non-porous surface makes cleaning and sanitizing faster and more effective.
- Constructed of superior Acrylic CXL™ with titanium reinforcement.
- At least 30% thicker and stronger than other makes.
- 2-year limited residential and commercial warranty.

- Before discarding box, check for accessories that may be packaged inside.
- All product measurements are ±1/2".
- Specifications and configurations are subject to change without notice.
- Measurements herein supersede all others published prior to publication date below.

See the Installation & Operation Manual for more details.
MTI's Customer Service: Monday-Friday 8am-6pm EST
800-783-8827 or service@mtibaths.com

