

HAMBURG COLLECTION

SINGLE KNOB (TO BE PAIRED WITH SINGLE SDH)

4407503

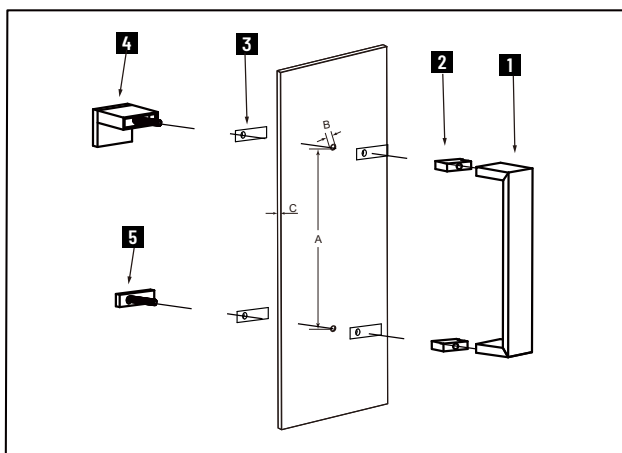
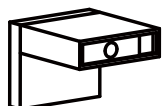

- 1.Handle x 1
- 2.Fixing Bracket x 4
- 3.Clear Gasket x 4
- 4.4407503 x 1
- 5.End Cap x 1

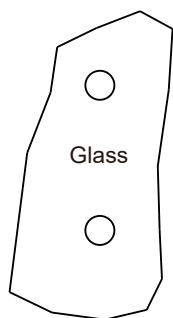

GLASS INFO		
A	3/8"(10mm)	Glass Hole Diameter
B	6-12mm	Glass Thickness

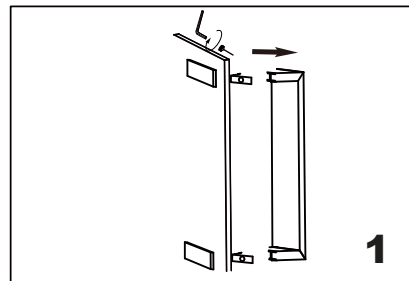

Loose the set screws and separate the handle and end caps.

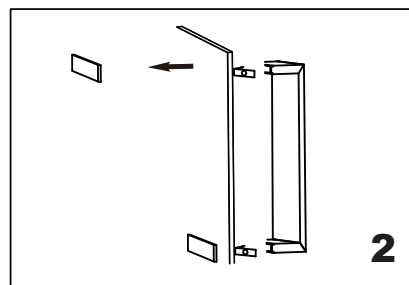

Remove the top end cap.

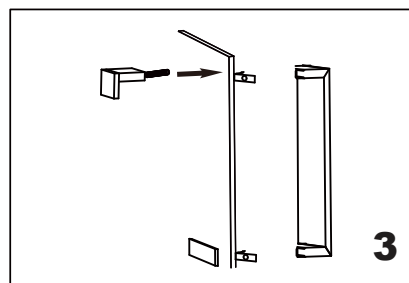

Fix the fixing bracket of 7503 on the bolt, and add the 7503 knob on the bracket.

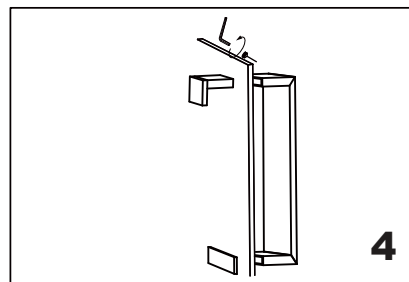

Fix the set screw on the end cap and knob, tighten it to avoid loose from fixing brackets.