

Heir Handshower Rail Set

18-31

Installation Instructions

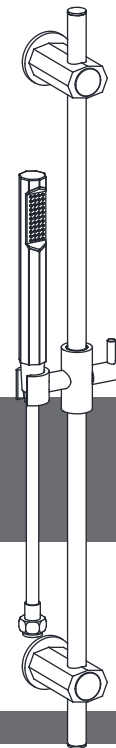

Introduction

This product has been fully inspected throughout the production process and only leaves our factory after a 15-step QC process. This handshower set is supplied with a mixed hot and cold water feed. Please ensure that the mixer that supplies this handset has had its hot and cold water pressures balanced, otherwise the handset will not function correctly.

The minimum water pressure required for this handset is 20 psi. The maximum water pressure is 60 psi, beyond which pressure-reducing valves must be fitted.

IMPORTANT: Please read these instructions carefully before beginning and retain for future reference.

Before beginning installation, check for any damage that may have occurred during transport. **Note: Damage claims cannot be made during or after installation.**

Improper installation shall result in loss of warranty in case of damage caused by impacts or rubbing against rough surfaces.

We do not accept responsibility for any problems that may occur through incorrect installation.

Installation notes

The installation must comply with all plumbing codes including local codes and be installed by a licensed plumbing contractor.

Before installing a new faucet it is essential that the supply pipes are thoroughly flushed in order to remove any remaining debris, solder or other impurities. Failure to carry out this simple procedure can cause problems or damage to the working of the faucet.

Installing shut-off valves on incoming supply lines is recommended for ease of maintenance.

Turn off the main water supply before connecting to any existing pipework or doing any maintenance.

IMPORTANT! Please check for any hidden pipes and cables, electric or otherwise, before drilling holes in a wall or floor.

Dimensions

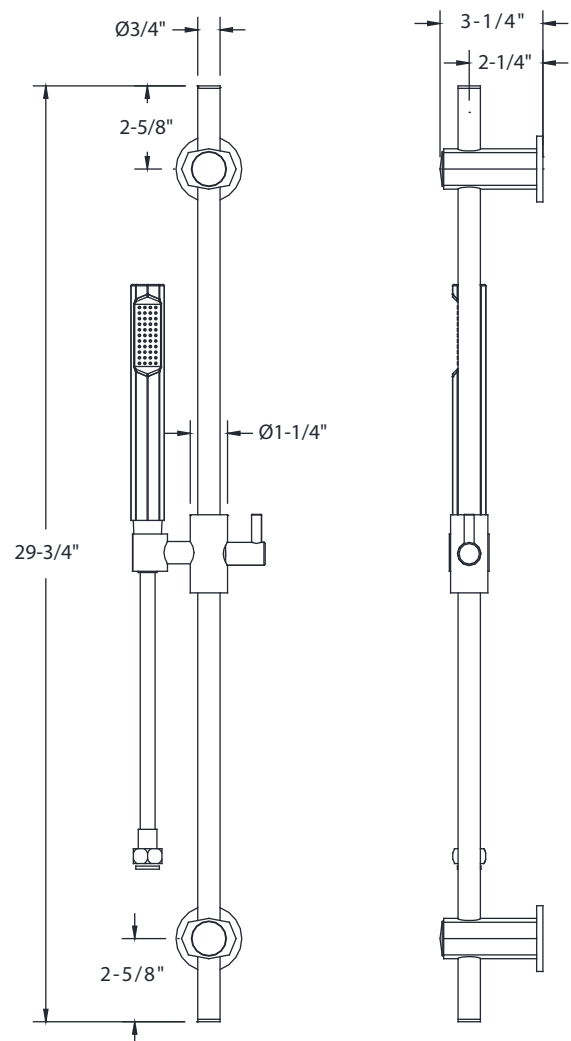

Tools required

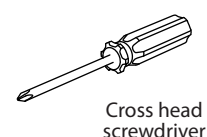
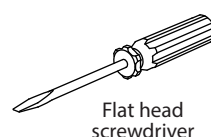
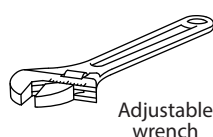
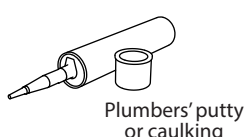
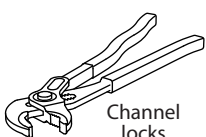

1 Installation

- Install the bracket on to the rail and fit the screw covers.
- Position the fixing base, mark the wall and drill holes. Insert the anchors into the holes.
- Secure the cover plate and rail by using the screws provided, then put on the cap.
- Connect the shower hose to the wall outlet (sold separately), and insert the handshower into the holder.

3 Cleaning Instructions

Rinse away any traces of soap and gently dry with a clean, soft cloth after each use. Rinse completely with water and dry any overspray. This will maintain the finish and avoid water spotting.

To remove mineral deposits, use a 50/50 solution of white vinegar and water. Do not allow the solution to soak on the product. Simichrome Polish® contains a protective film to enhance maintenance and is helpful in preventing water spot buildup. Follow instructions to ensure optimum results.

Never use an abrasive material such as a brush or scouring pad to clean the surface. The use of abrasive cleaners, cleansers or disinfectants will alter the surface finish and void the warranty.

Do not allow certain materials such as toothpaste, cologne, shaving cream, nail polish remover, vinegar, wine, drain and glass cleaners to remain on the surface. Prolonged contact will alter surface finishes and void the warranty.

We DO NOT recommend using any household cleaners as many can cause damage to the finish.

Please see the website for care instructions for specific finishes.

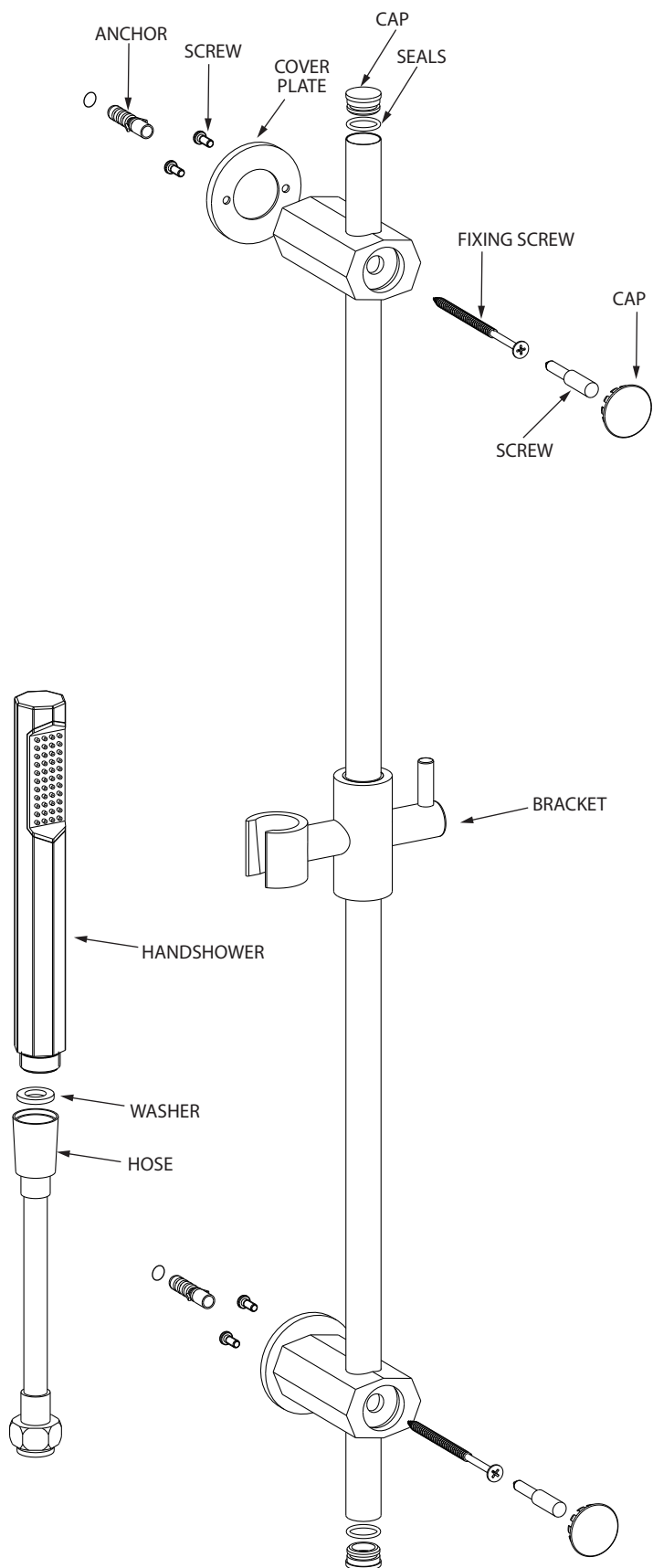

Warranty - This **Crosswater London** product is covered by a limited lifetime warranty. For full details, terms and conditions please visit our website.

For further information contact: **Crosswater London**, 393 Fortune Blvd., Milford, MA 01757

Toll free number: 844-XWATER-1 (844-992-8371) tel: 508-381-0433 fax: 508-381-6068

www.crosswaterlondon.com

email: technical@crosswaterlondon.com

Issue date: 19072021